

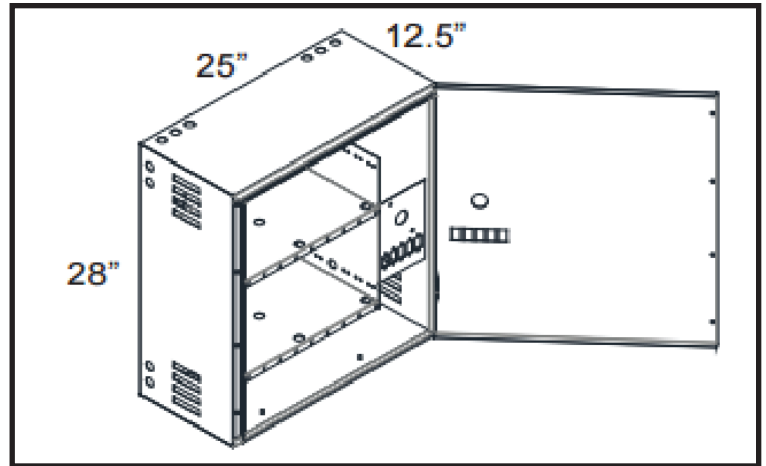

## CEPS-B-1500

Central Emergency Power System Lighting Inverter (1500W)



### APPLICATION

CEPS are typically used in one of three applications:

- In a standalone application, a single CEPS powers all emergency lighting for a building or space
- In a multi-inverter application, multiple CEPS power a larger emergency lighting load. Typically, the CEPS will be mounted in smaller electrical rooms or closets close to the lights powered by the inverter. Since large inverter or generator systems are typically broken into multiple circuits, using several CEPS provides greater reliability (no single point of failure), while making troubleshooting and service easier. Unlike large multiple kW systems, the CEPS does not require a factory service tech for service. This solution is economically competitive with standalone large systems in both initial and maintenance costs.
- In a generator backup application, a CEPS will provide power to emergency lighting during the period (up to several minutes) after utility power is interrupted, but before the generator starts up. If the generator fails to start, the CEPS will carry the entire emergency load for up to 90 minutes.

### FEATURES

- Operates fluorescents, dimmable fluorescents ballasts, CFL, LED, halogen & incandescent loads.
- Self-resetting overload protection and fused output
- Automatic Output Voltage Tracking maintains output voltage at full load  $\pm 3\%$
- 120VAC and 277VAC Pure Sine Wave Output 1500W load for 90 minutes
- Sealed Lead Calcium batteries provide long life and are maintenance free
- 3/6 Warranty (3 year replacement warranty on electronics, 6 year pro-rata warranty on batteries)
- Automatic low voltage battery disconnect, deep discharge protection, over-temperature, shut down and reverse polarity protection



15007 Wicks Blvd. San Leandro, CA 94577 | 1-800-982-4587  
techsupport@lvscontrols.com | www.lvscontrols.com  
Specifications subject to change without notice.



# SINGLE LINE DRAWING

Note: LVS suggests to derate inverter by 15% with all lighting loads to greatly reduce inrush related problems.

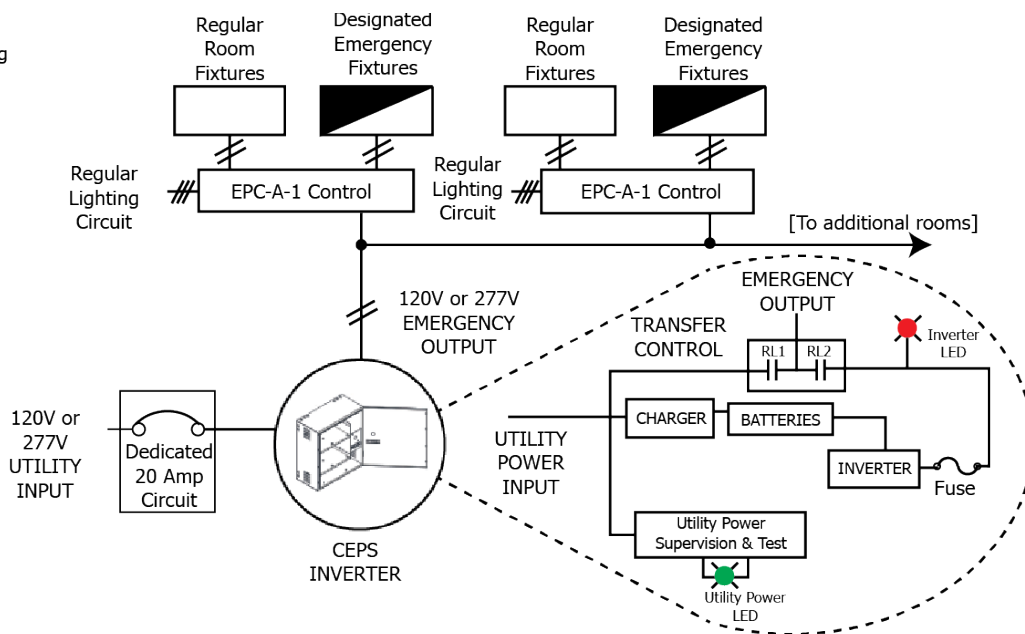

# SPECIFICATIONS

<b>ELECTRICAL RATINGS</b>	<b>MODEL NUMBER</b>	CEPS-B-1500W
	<b>SENSING INPUT</b>	120VAC/277VAC
	<b>LOAD VOLTAGE</b>	1500W
	<b>TEMPERATURE</b>	4.4°C - 37.8°C (40°F - 100°F)
	<b>BODY SIZE</b>	25" x 28" x 12.5"
	<b>WARRANTY</b>	3/6 Warranty (3 year replacement warranty on electronics, 6 year pro-rata warranty on batteries)

